

Install method

1

Connect the power supply line

- When installing dryer without junction box, you should install above the right side of dryer two-hole standard outlet corresponds to hand dryer. The distance should be 20-50cm.
- Please embed junction box without cover in the installation location when directly connecting power cord is needed. Otherwise, power cord will be forced out of body and can not be properly installed.

2

Cover removal

- Use the Allen wrench from accessories bag to remove 2 countersunk screws from cover.
- Pull the cover upward by hands to remove.
- Keeping the cover carefully to avoid scratching.

3

Machine installation

- As figure shows, the machine is to be fixed on the wall by screws.
- The machine has been equipped with a power cord. If needing junction box for installation, the power cord must be removed.
- As figure shows, the wire is drawn out through thread hole to the terminal blocks to connect.

When connecting, the wire length should exceed 2cm to terminal block. Fire line must be connected at L position of terminal blocks, null line connected at N position.

4

Cover installation

- Tighten the 2 countersunk screws on the cover.

Test run

Steps	Confirm information	Check & Notice
1 Shake the machine gently	The machine is installed firmly without shaking	It will occur shaking and noisy when the machine doesn't install firmly
2 Confirm the power and voltage	Please use the rated power Voltage	It will burn out machines or cause accidents if the power use is incorrect
3 Switch on the power	Close external power supply switch or insert the power plugs	Power socket must match the machine plug Please check the power when the indicator light is off
4 Place your hands in the drying area	High speed air blown out	Please confirm whether your hands are far away from the sensor parts if there is no air blowing out

Daily use and maintenance

1

External maintenance

- Clean with a soft dry cloth or towel Sassafra. Please use neutral detergent. Please don't use organic solvents, acid or alkali toilet cleaner, cleaning brush etc.
- Otherwise, this will damage the machine surface finish or produce discoloration.

2

Packing list

main machine	1	User manual	1
5×25mm self tapping screw	4	Allen wrench	1
5mm expansion pipe	4		















Specification

Voltage	AC220-240V~	Motor	Brush motor
Phase	Single-phase	Sensing distance	15-20cm
Input	1150-1350W	Protection class	IPX1
Wind speed	60m/s	Appearance size	260x180x152mm
Heating power	650-750W	N.W	3.0kg



WARNING

If you don't use this unit properly or follow the safety guidelines carefully. It would lead to serious personal injury or property damage

-  Do not open the front panel. Otherwise, you may get an electric shock.
-  Do not let children hang from the unit. Otherwise, this may cause the unit to drop.
-  Do not allow the unit to get wet. Otherwise, it will cause electric shock.
-  Do not use in a web environment, for example, near the bathroom where it may get direct water and the places where condensation may form. Otherwise, this may cause electric shock and unit malfunction.
-  Do not modify and disassemble the unit unnecessarily. Otherwise, this may cause a fire, electric shock, or personal injury.
-  Rated power is required.
-  If power tolerance is over +/-10%, there will be breakdown. If using incorrect power supply, fire, electric shock and machine malfunction will happen.
-  Please use dedicated socket.
-  If using together with other appliances, the socket may cause abnormal heat leading to fire.
-  Power must be cut off when maintenance to prevent the risk of electric shock.
-  Air filter must be installed.
-  If the machine doesn't work or have abnormal conditions, please cut off power to prevent accidents; and close leakage circuit breaker and ask supplier to check and repair, or it may lead to fire because of electricity leakage and short circuit.
-  Machine must have reliable ground connection.
-  Attention when installation:
 - Do not install when the machine has power connected.
 - This appliance is not intended for use by persons (including children) with reduced physical, sensory or mental capabilities, or lack of experience and knowledge, unless they have been given supervision or instruction concerning use of the appliance by a person responsible for their safety.
 - If the cord is damaged, it must be replaced by the manufacturer, its service agent or similarly qualified persons in order to avoid a hazard.
 - For additional protection, the installation of a residual current device (RCD) having a rated residual operating current not exceeding 30mA is advisable in the electrical circuit supplying the bathroom. Ask your installer for advice.

Warning



- Environmental Protection
Waste electrical products should not be disposed of with household waste. Please recycle where facilities exist. Check with your Local Authority or retailer for recycling advice.

Feature

- No touch hand drying ensures complete hygiene.
- No need for paper towels, ease of maintenance.
- Stainless steel cover, solid and beautiful appearance.
- Auto-stop function, the built-in time will stop the unit after 40 seconds.
- The machine is equipped with automatic heating system, when temperature is cold, it automatically opens the heating system, when the temperature is hot, the heating system automatically shutdown.

Name of each part

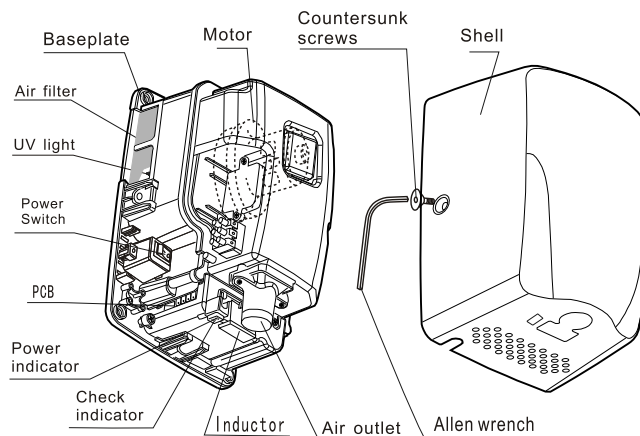

Electrical diagram

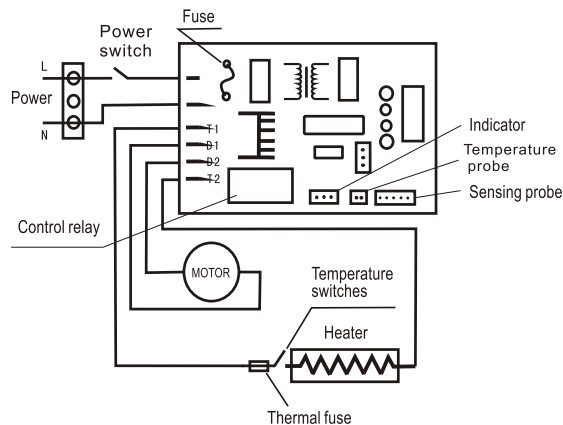

Precautions before installation and Installation location

■ Do not install in the following places (otherwise may cause malfunction).

- Place with temperature below 10°C or above 40°C
- Place directly sprinkled by water
- Place with direct sunlight, strong light
- Place easy for condensation
- Place filled with corrosive, oxidizing and reducing gas
- Place with altitude over the range of 0 ~ 2000m

■ Installation location

- The following picture shows the recommended location.
(If there is floor or obstacles below the hand dryer, the distance between machine and floor or obstacles should be at least 400mm.)
- Keep the right side of dryer away from mirror or wall, for the water droplets may splash out when you dry hands. (the distance should be 100mm or above)
- Please avoid the place easy to meet people and easy to encounter doors.
- Please select flat wall to install this product.

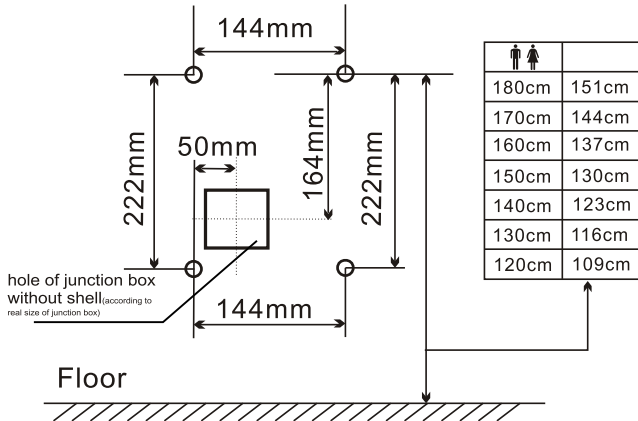

- Power cord should be 1.5mm²-2.0mm²



Intelligent Facility Solutions Ltd
 Electric Works
 3 Concourse Way
 Sheffield
 S1 2BJ

phone: +44 (0)114 354 0047
 email: service@ihdryers.co.uk
 www.intelligenthanddryers.com